

TSBR5100LBF

5.0AMPS. SCHOTTKY BARRIER RECTIFIERS

FEATURE

- . For surface mounted application
- . High current capability
- . Low forward voltage drop
- . Low power loss, high efficiency
- . High surge current capability
- . High temperature soldering guaranteed:
260°C/10 seconds at terminals.

MECHANICAL DATA

- . Terminal: Solder plated
- . Case: Molded with UL-94 Class V-0 recognized
Flame Retardant Epoxy
- . Polarity: color band denotes cathode
- . Packaging: 12mm tape per EIA STD RS-481

SMBF

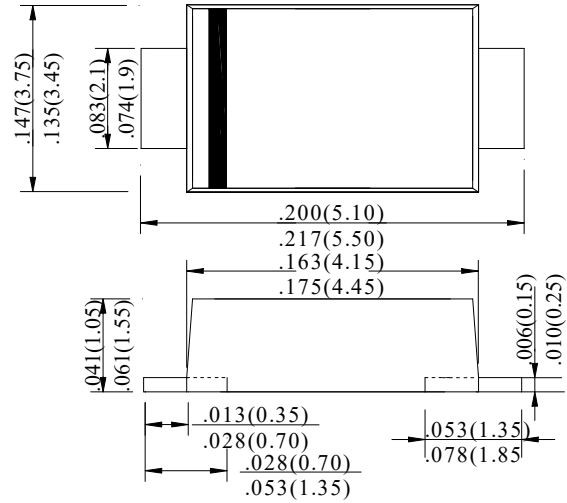

Dimensions in inches and (millimeters)

MAXIMUM RATINGS AND ELECTRICAL CHARACTERISTICS

Ratings at 25°C ambient temperature unless otherwise specified.

Single phase, half wave, 60Hz, resistive or inductive load. For capacitive load, derate current by 20%

Type Number	SYM BOL	TSBR5100LBF	units
	marking	T5100L	
Maximum Recurrent Peak Reverse Voltage	V_{RRM}	100	V
Maximum RMS Voltage	V_{RMS}	70	V
Maximum DC blocking Voltage	V_{DC}	100	V
Maximum Average Forward Rectified Current	$I_{F(AV)}$	5.0	A
Peak Forward Surge Current 8.3ms single half sine- wave superimposed on rated load (JEDEC method)	I_{FSM}	120.0	A
Maximum Forward Voltage at 5.0A DC	V_F	0.62	V
Maximum DC Reverse Current @ $T_J=25^\circ\text{C}$ at rated DC blocking voltage @ $T_J=100^\circ\text{C}$	I_R	0.2 10.0	mA
Typical Junction Capacitance (Note1)	C_J	650	pF
Typical Thermal Resistance (Note 2)	$R_{(JA)}$	55	°C/W
Storage Temperature	T_{STG}	-55 to +150	°C
Operation Junction Temperature	T_J	-55 to +150	°C

Note:

1. Measured at 1.0 MHz and applied reverse voltage of 4.0Vdc
2. Measured on P.C.Board with 0.2×0.2”(5.0×5.0mm)Copper Pad Areas.

RATING AND CHARACTERISTIC CURVES

FIG.1-TYPICAL FORWARD CURRENT DERATING CURVE

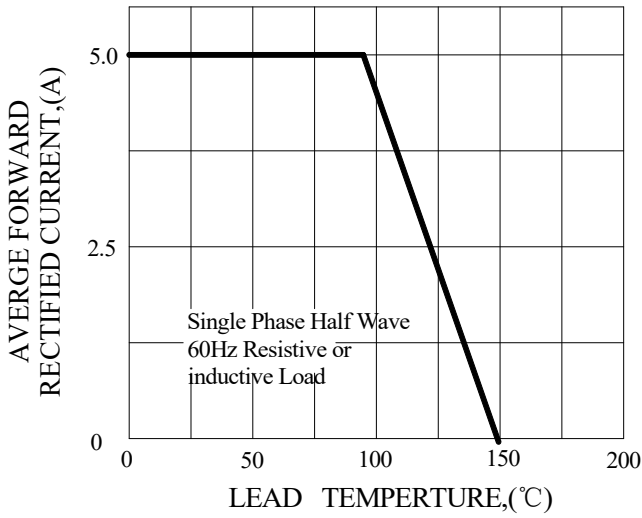

FIG.2-TYPICAL INSTANTANEOUS FORWARD CHARACTERISTICS

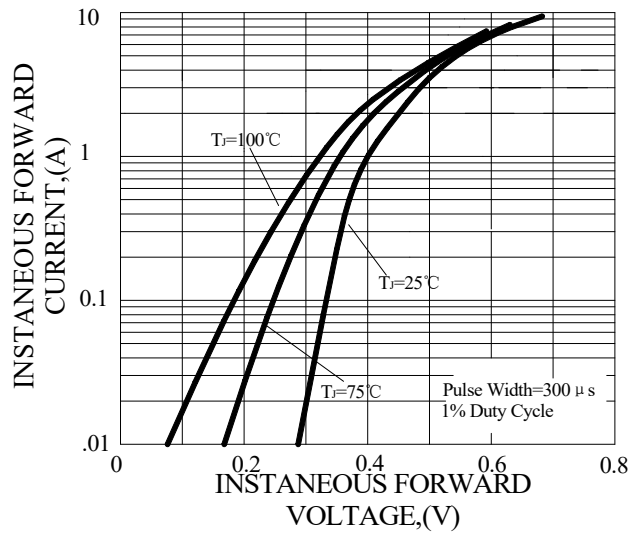

FIG.3-MAXIMUN NON-REPETITIVE FORWARD SURGE CURRENT

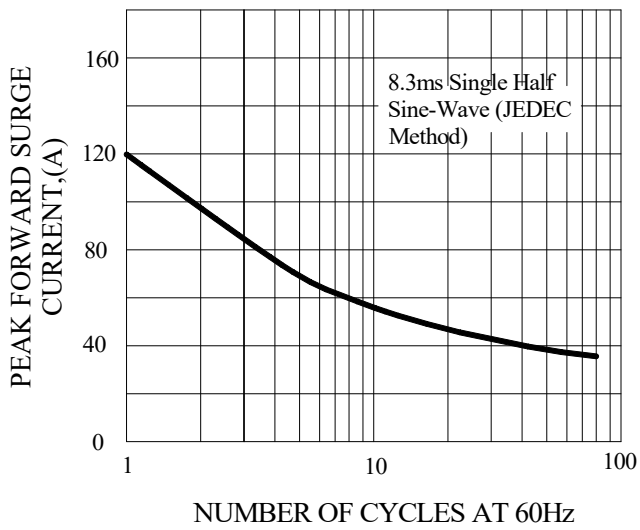
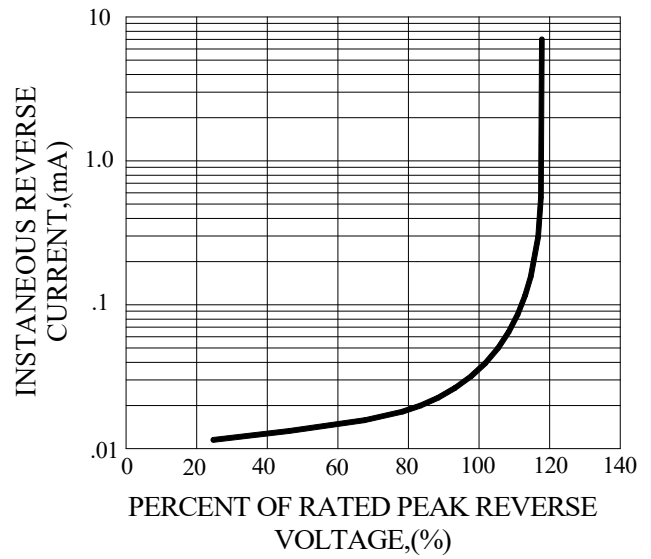
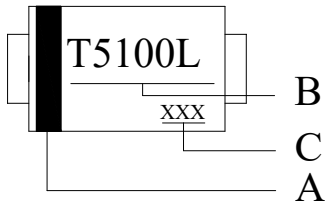

FIG.4-TYPICAL REVERSE CHARACTERISTICS



Marking and packaging illustration

1、Marking



SYMBOL	Explanation
A	Color Band Denotes Cathode
B	Product name
C	Date Code

2、Packaging

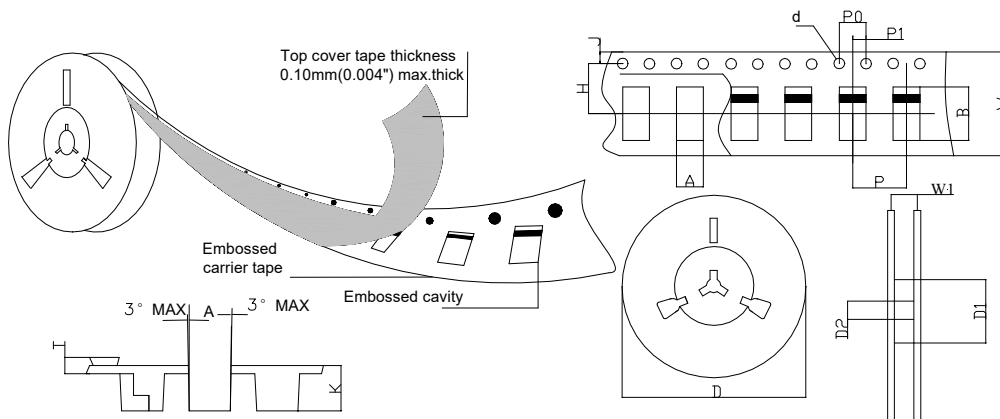

SPECIFICATIONS mm(inch)		PACKAGE	SPECIFICATIONS mm(inch)		PACKAGE
ITEM	SYM BOL	SMBF	ITEM	SYM BOL	SMBF
Carrier width	A	3.81(0.150)Max	Carrier depth	K	1.6(0.063)Typ
Carrier length	B	5.61(0.221)Max	Punch hole pitch	P	8.00(0.315)Typ
Sprocket hole	d	∅1.55(0.061)Typ	Sprocket hole pitch	P0	4.00(0.157)Typ
Reel outer diameter	D	330.0(13.0)Typ	Embossment center	P1	2.00(0.079)Typ
Reel inner diameter	D1	153.0(6.02)Min	Overall tape thickness	T	0.30(0.012)Typ
Feed hole diameter	D2	77.0(3.03)Typ	Tape width	W	12.0(0.472)Typ
Sprocket hole position	J	1.75(0.069)Typ	Reel width	W1	12.4(0.488)Min
Punch hole position	H	5.50(0.216)Typ			